

FORMS



dois . two

forms



DO.5011.AO



DO.5021.AO

# DOMINÓ

"Desenhar um produto é  
desenhar uma relação."

Steve Rogers







**Características técnicas**

Sofás de 1, 2 ou 3 lugares com braços.  
Sistema modular, permite diversas configurações consoante espaço, disponível e uso pretendido.

Estrutura interior em madeira.  
Espuma flexível de densidade múltipla.  
Suporte através de 4 pés cilíndricos em alumínio.

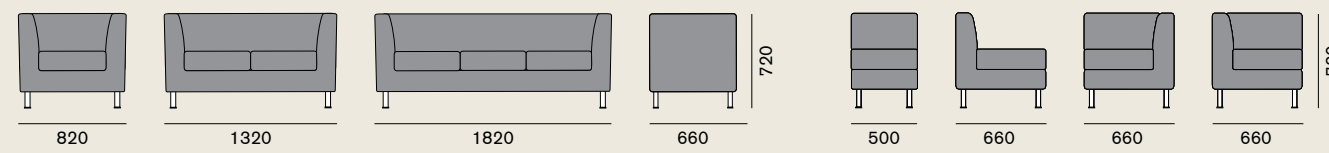



HS.5021.00



HS.5011.00

# HERITAGE

"Unidade e simplicidade são as duas verdadeiras fontes de beleza."

Johann Joachim Winckelmann



MI.5806.CO



HS.5011.00





14



HS.5021.00

#### Características técnicas

Sofás de 1 ou 2 lugares com braços.  
Espuma flexível de alta densidade.  
Estrutura de suporte em tubo de aço de  
secção circular com acabamento cromado.

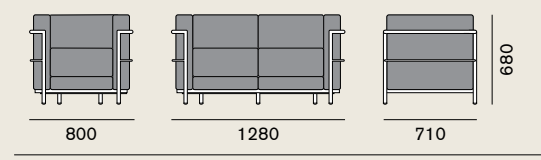

NOVIDADE 2014

# MARSHALL

Sistema modular de sofás de recepção. As três versões disponíveis permitem configurar vários tipos de conjuntos consoante a dimensão do espaço, número de lugares desejado e geometria do local. Lugares localizados nas extremidades poderão ser equipados com braços de apoio.





MARSHALL





MH.5100.CO  
c/ MH.BFC



MH.5200.CO



MH.5300.CO

# MARSHALL

Costa: Espuma moldada.

Assento: Espuma moldada.

Braços: Apoio fixo na extremidade (opcionais). Revestido.

Versões: Sistema modular com opção de convexo, concavo ou direito.

Acabamento da estrutura: Acabamento cromado.

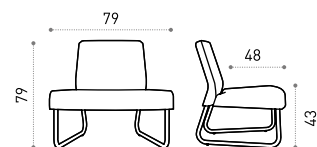
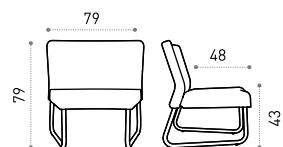
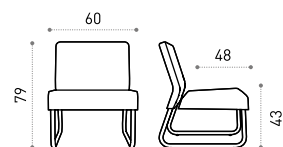



# Mr. JONES



MJ.5011.00



MJ.5021.00

# Mr. JONES





Mr. JONES





MJ.5710.00 + MJ.5910.00 + MJ.5910.00 + MJ.7000.00 + MJ.5910.00 + MJ.5910.00 + MJ.7000.00 + MJ.5810.00

# Mr. JONES



DESIGN BY  
ORLANDINI DESIGN

Sistema modular de sofás, com fabrico em espuma moldada.  
Pés em cinza, permitem regulação de altura para nivelção.

### Disponível nas seguintes versões

- Individual com braços laterais
- Individual com braço direito
- Individual com braço esquerdo
- Individual sem braços
- Individual sem braços para canto côncavo
- Individual sem braços para canto convexo
- Pouf de apoio
- Duplo com braços laterais



MJ.5710.00



MJ.5910.00



MJ.5810.00



MJ.6000.00



MJ.7000.00



MJ.4000.00

### VARIANTES

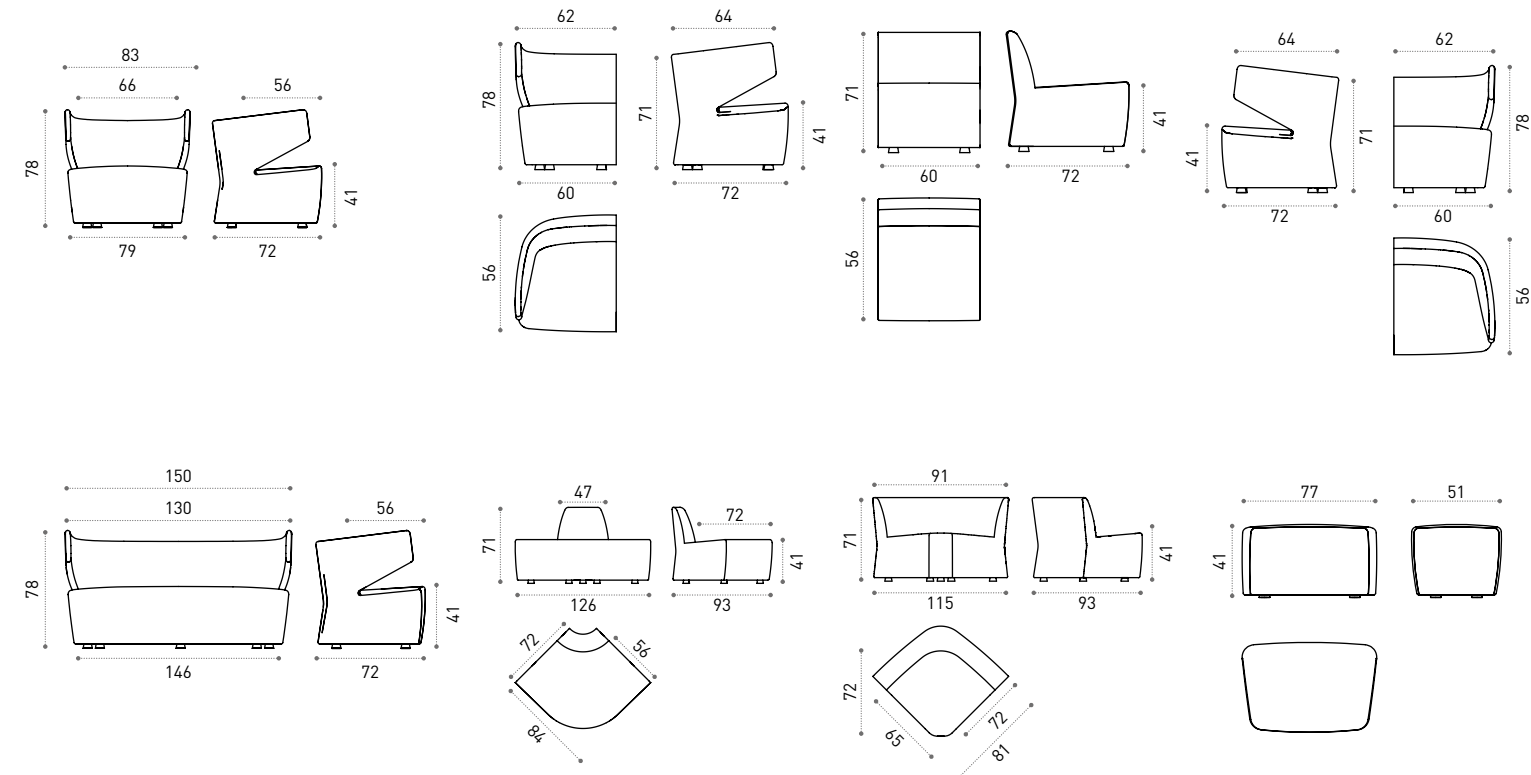

# PIPE



**Versão disponível:** Puff individual. ●  
**Available version:** Single puff.

**Costa e assento:** Integralmente revestido. —  
Peça única em espuma moldada.  
**Backrest and seat:** Fully upholstered.  
Single body in molded foam.

**Suporte:** 4 pontos de apoio. Polipropileno. —  
**Support:** 4 feet. Polypropylene.



▲ PP.4000.00

# SEATING SOLUTION FOR MEETING AND WAITING AREAS



**Versões:** Giratória disponível com base de 4 raios. ●  
**Versions:** Swivel available with 4 spokes base.

**Costa e assento:** Integralmente revestido. Espuma flexível. —  
**Backrest and seat:** Fully upholstered. Cut foam.

**Suporte:** Base plana de 4 raios em aço com acabamento —  
pintado ou base piramidal de 4 raios em poliamida, em  
alumínio polido ou em madeira de faia.  
**Support:** 4 spokes base in flat angle in steel with paint finish.  
4 spokes base in high pyramid format in nylon, in polished  
aluminum or beech wood.

▲ PY.2100.AO.02



QB.5011.00



QB.5011.00

## QUADRA/B

"Criatividade é pensar de forma mais eficiente."

Pierre Reverdy



AL.5812.CO



QB.5011.00





#### Características técnicas

Sofás de 1, 2 ou 3 lugares com braços.  
Estrutura interior em madeira.  
Espuma flexível de densidade múltipla.

#### Opções de suporte

- Estrutura de suporte em alumínio (Quadra).
- Estrutura em tubo de aço de secção quadrado pintado a cinza RAL 9006 liso (Quadra B).
- 4 pés cilíndricos em alumínio (Quadra B).

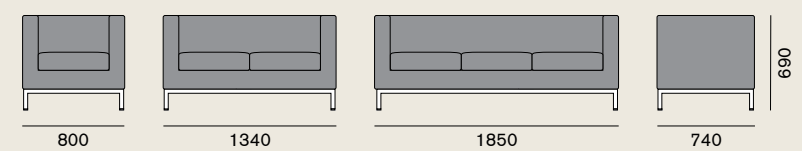



# SMILE

"Cores, como características,  
seguem as mudanças  
das emoções."

Pablo Picasso







#### Características técnicas

Sofás de 1 ou 2 lugares.  
Estrutura interior metálica.  
Espuma flexível de densidade múltipla.  
Suporte por 4 pés pintados a cinza  
RAL 9006 liso com apoios de contacto  
ao solo  
Barra de ligação pintada a cinza RAL  
9006 liso.

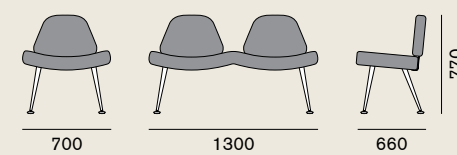



SA.5111.AO



SA.5011.CO

## SPARK

"O design de um produto não está terminado até alguém o esteja a usar."

Brenda Laurel



TW.5806.CO



SA.5111.AO





SA.5011.CO

#### Características técnicas

Sofá de 1 lugar com braços.  
Estrutura interior em madeira.  
Espuma flexível de densidade múltipla.

#### Opções de suporte

- Estrutura em tubo de aço de secção quadrada com acabamento cromado ou pintado a cinza RAL 9006 liso (ref.: SA.5011.CO).
- Estrutura integrada do sofá com 4 apoios de contacto ao solo (ref.: SA.5111.CO).

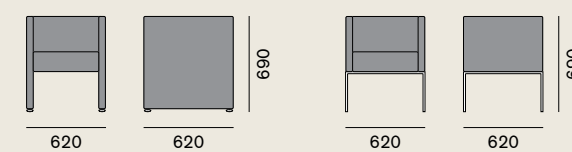



VR.5011.CO



VR.5011.CO

# VÉRTICE

"Simplicidade é a  
sophistication definitiva."

Leonardo da Vinci



EX.6000.CO



VR.5011.CO





VR.5011.CO

#### Características técnicas

Sofá de 1 lugar com braços.  
 Estrutura interior em madeira.  
 Espuma flexível de densidade múltipla.  
 Estrutura em tubo de aço de secção quadrada  
 com acabamento cromado ou pintado a cinza  
 RAL 9006 liso.

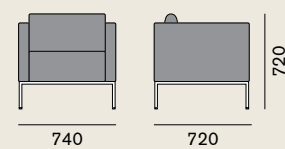

740

720

720